

Article number: 0107047

Description: Retaining ring AK 30 DIN 983

Measures

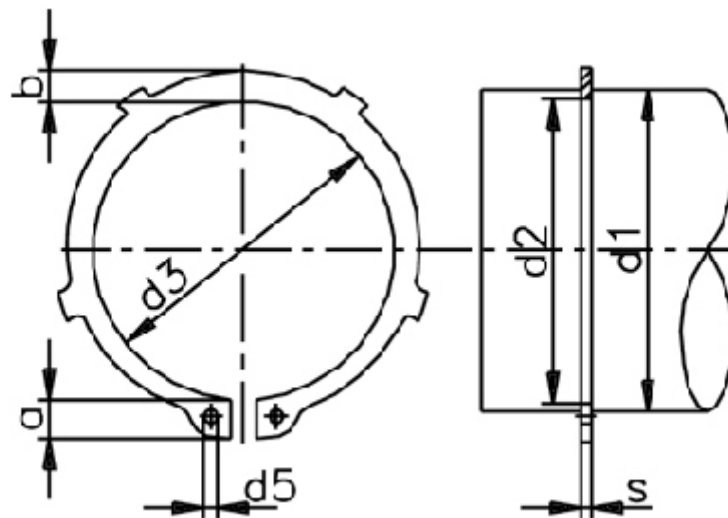

a max	= 4.7	FN kN	= 10.70	Number of serrations	= 6
AN mm ²	= 64.4	FRg kN	= 7.6	s	= 1.50
b	= 3.4	FR kN	= 32.1	t	= 0.70
d1	= 30	g	= 1.5	tol	= -0.21
d2	= 28.6	K kN-mm	= 64.2	tol	= -0.06
d3	= 27.9	m min	= 1.60	tol	= +0,21-0,42
d5 min	= 2.0	n abl x 1000	= 18	Tong	= ZGA-2
Description	= AK 30	Nominal drive	= 2.1	Weight kg/1000	= 3.65